

SPICE thermal model

BUK9K20-80E

Symbol	Parameter	Conditions	Min	Typ	Max	Unit
$R_{th(j-mb)}$	thermal resistance from junction to mounting base		-	-	2.21	K/W

C_{th1}	3.976E-05 F
C_{th2}	2.164E-04 F
C_{th3}	3.017E-04 F
C_{th4}	1.378E-03 F
C_{th5}	5.688E-03 F
C_{th6}	6.507E-03 F
C_{th7}	1.055E-01 F
R_{th1}	2.295E-03 Ω
R_{th2}	5.374E-03 Ω
R_{th3}	3.333E-02 Ω
R_{th4}	6.878E-02 Ω
R_{th5}	2.139E-01 Ω
R_{th6}	1.358E+00 Ω
R_{th7}	5.236E-01 Ω

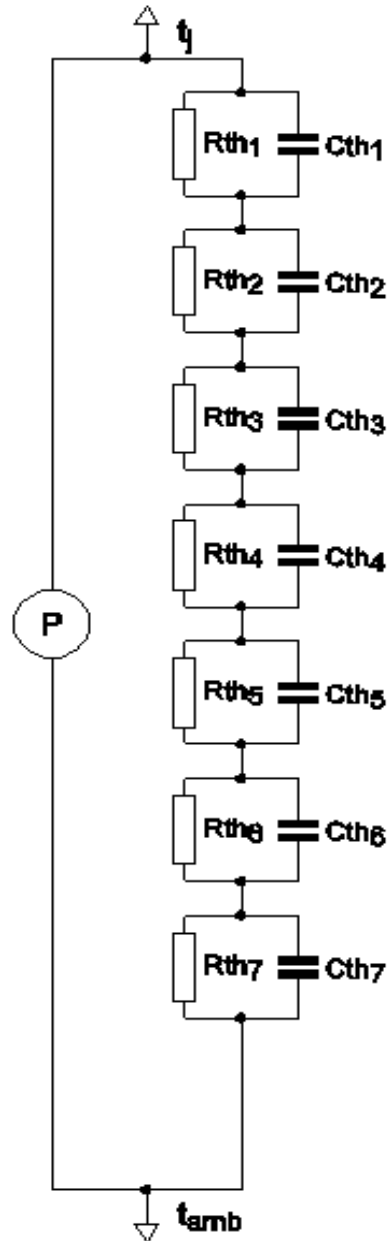

Part: BUK9K20-80E
 Date: 15/6/2017
 Model Rth 2.21 K/W